

DRINKER BIDDLE & REATH LLP  
A Delaware Limited Liability Partnership  
500 Campus Drive  
Florham Park, New Jersey 07932-1047  
(973) 549-7000  
Attorneys for Defendants  
DEPUY ORTHOPAEDICS, INC., DEPUY, INC.,  
DEPUY INTERNATIONAL LIMITED,  
JOHNSON & JOHNSON INTERNATIONAL,  
JOHNSON & JOHNSON SERVICES, INC., AND  
JOHNSON & JOHNSON

**FILED**  
JUN 17 2011  
BRIAN R. MARTINOTTI, J.S.C.

---

IN RE DEPUY ASR™  
HIP IMPLANTS LITIGATION

---

: SUPERIOR COURT OF NEW JERSEY  
: LAW DIVISION: BERGEN COUNTY

: CASE CODE 293

: CIVIL ACTION

This Document Relates to All Actions

: **CASE MANAGEMENT ORDER NO. 4**  
:  
: **(EXPLANT PRESERVATION ORDER)**

---

**THIS MATTER** having been opened to the Court by lead counsel for the parties, and the parties consenting to the form, substance and entry of the Order, and for good cause shown,

**IT IS** on this 17<sup>th</sup> day of June 2011;

**ORDERED** as follows:

(1) Pursuant to the Court's duty to supervise pretrial proceedings in this case, including discovery, and pursuant to the Court's inherent power, the Court hereby orders, effective immediately, that DePuy Orthopaedics, Inc. ("Defendant") and Plaintiffs (collectively, "the Parties") shall comply with the following directives relating to the preservation of explants in the above-captioned matter:

**A. Definitions**

**Device Subject to This Order**

The provisions of this Order shall pertain to the following:

1. **DePuy ASR™ Device** means the ASR™ Hip System Device and components

marketed and sold by Defendant in the United States.

2. **Explanted DePuy ASR™ Device** means the ASR™ Hip System Device and components explanted from patients in the United States, and tissue samples if retrieved during surgery. The provisions of this Order shall also pertain to any other DePuy ASR™ Devices that have been explanted and returned to Defendant that, through reasonable efforts, can be identified as having been implanted in any patients in the United States (hereinafter all referred to as “Explanted DePuy ASR™ Devices”).

**B. Preservation Protocol**

The Parties agree that the Preservation Protocol, appended hereto as Exhibit A, represents a reasonable protocol designed for the preservation of Explanted DePuy ASR™ Devices and surrounding tissues which may constitute evidence related to any design or manufacturing claim which Plaintiffs may assert in this litigation. Defendant will not object to the request by or on behalf of a Plaintiff that the explanting surgeon and/or hospital retain and preserve synovial fluid and/or whole blood/serum pursuant to retention and preservation procedures to be established by and for that individual Plaintiff.

Recognizing that each explant procedure is within the purview and control of non-party medical practitioners and hospitals where surgeries occur, any departure from the attached Preservation Protocol by non-party medical practitioners and hospitals shall not constitute the spoliation of evidence by any of the Parties.

**C. Physical Evidence**

The Parties shall make good faith efforts with non-party medical practitioners and hospitals to preserve any Explanted DePuy ASR™ Devices within their possession, custody or control that may be relevant to the claims, defenses, or subject matter of this litigation.

Defendant will not take steps which inhibit requests by or on behalf of a Plaintiff to have their surgeon and/or hospital retain and preserve any Explanted DePuy ASR™ Device, synovial fluid, and/or whole blood/serum or any other physical evidence.

**1. Non-Destructive Inspection and Analysis**

Non-destructive inspection and analysis by the Parties or their designated contract laboratory(s) of Explanted DePuy ASR™ Devices are allowed. The Parties agree that the “Procedure for Laboratory Inspection of ASR™, ASR-XL™ and Related Components” (“Inspection Protocol”), one of the Preservation Protocols appended hereto as Exhibit A, represents a reasonable non-destructive protocol designed for the inspection of Explanted DePuy ASR™ Devices which may constitute evidence related to any design or manufacturing claim which Plaintiffs may assert in this litigation. The Parties will not object to any inspection of Explanted DePuy ASR™ Devices which is reasonably consistent with the Inspection Protocol, and this Order, and any inspection of Explanted DePuy ASR™ Devices which is reasonably consistent with the Inspection Protocol, and this Order, shall not constitute the spoliation of evidence by any of the Parties. If counsel of record for a Plaintiff so chooses, a Plaintiff’s Explanted DePuy ASR™ Device may be obtained from the Plaintiff’s surgeon or the hospital where the surgery occurred and sent to a contract laboratory(s) of Plaintiffs choice, or a designated storage facility, subject to the requirement that the explant shall be preserved in accordance with the attached Preservation Protocol and inspection and analysis shall be non-destructive, and reasonably consistent with the attached Inspection Protocol, and this Order. Absent that choice by counsel of record for a Plaintiff, DePuy will make arrangements for Explanted DePuy ASR™ Devices to be sent to Orthopaedic Hospital, Los Angeles, California, with the requirement that the explant shall be preserved in accordance with the attached

Preservation Protocol and inspection and analysis shall be non-destructive, and reasonably consistent with the attached Inspection Protocol, and this Order. Except as permitted in the attached Preservation Protocol and Inspection Protocol, the parties will take reasonable measures with their respective contract laboratories and/or designated storage facilities to maintain the Explanted DePuy ASR™ Devices, including all component parts, in the same condition as they were in when received, including refraining from altering the structure, existence, integrity and nature of the device surfaces as explanted. Except as otherwise permitted by this Order, all Explanted DePuy ASR™ Devices obtained by the Parties from surgeons or from the hospital where a Plaintiff's surgery occurred shall be retained by the receiving party, its designated contract laboratory(s) or designated storage facility unless otherwise agreed by the Parties.

**2. Surgically Removed DePuy ASR™ Device in Plaintiffs' or Defendant's Possession**

In the event that prior to the entry date of this Order, an Explanted DePuy ASR™ Device has been obtained by either Plaintiffs or Defendant, the Parties agree as follows:

(i) For each Plaintiff who has obtained an Explanted DePuy ASR™ Device, notice of that fact will be provided to Defendant, along with information as to the date of the explantation, the location of the explant, whether synovial fluid and/or whole blood/serum were retained, and an acknowledgement that the explant will be preserved, and that any further inspection and testing shall be in accordance with the provisions of this Order and the attached Preservation Protocol.

(ii) For each Plaintiff for whom DePuy may have obtained an Explanted DePuy ASR™ Device, notice of that fact will be provided to Plaintiffs Counsel of record, along with information as to the date of the explantation, the location of the explant, and an acknowledgement that the explant will be preserved, and that any further inspection and testing

shall be in accordance with the provisions of this Order and the attached Preservation Protocol. Upon request, DePuy will return the explant to Plaintiff's counsel of record upon receipt of an acknowledgement that the explant will be preserved, inspected and tested in accordance with the provisions of this Order and the attached protocols. If the request for forwarding arrives prior to the completion of the testing and inspection, then (a) the inspection shall stop immediately and (b) the DePuy Laboratory shall seek approval to either complete the inspection or will forward the device as requested. If a Plaintiff's Explanted DePuy ASR™ Device was obtained prior to the entry of this Order, and has been inspected or tested, the results of such inspection and testing shall be made available to counsel of record for the opposing party. The Parties agree that the mere failure to follow the Preservation Protocol attached to this Order for such Explanted DePuy ASR™ Devices received prior to the entry of this Order shall not constitute the spoliation of evidence.

**D. Inspection Results**

The Parties agree to exchange the results of all inspection and testing done by their respective contract laboratory(s) on all Explanted DePuy ASR™ Devices, including the exchange of all data generated as a result of the inspection and testing, photographs, and other information generated as a result of the inspection, and testing Preservation Protocol attached to this Order.

**1. For Defendant Obtained Explanted DePuy ASR™ Devices**

For Explanted DePuy ASR™ Devices obtained from surgeons or hospitals by Defendant, upon request and after the completion of the inspection and testing by Defendant's contract laboratory, Plaintiff has the right, at their expense, to request that their Explanted DePuy ASR™ Device be sent to a contract laboratory of Plaintiff's choice for further inspection and testing.

Plaintiff is entitled to receive the results of the inspection and testing performed by or at the request of Defendant, including the exchange of all data generated as a result of the inspection and testing, photographs, and other information generated as a result of the inspection.

Defendant is entitled to receive the results of the inspection and testing performed at the request of Plaintiff, including the exchange of all data generated as a result of the inspection and testing, photographs, and other information generated as a result of the inspection.

**2. For Plaintiff Obtained Explanted DePuy ASR™ Devices**

For Explanted DePuy ASR™ Devices obtained from surgeons or hospitals by Plaintiff, upon request and after the completion of the inspection and testing by Plaintiff's contract laboratory, Defendant has the right, at their expense, to request that the Explanted DePuy ASR™ Device and synovial fluid and/or whole blood/serum, if retained, and if any remains after Plaintiff's testing, be sent to a contract laboratory of Defendant's choice for further inspection and testing. Defendant is entitled to receive the results of the inspection and testing performed at the request of Plaintiff, including the exchange of all data generated as a result of the inspection and testing, photographs, and other information generated as a result of the inspection, including any information or data from the testing of synovial fluid and/or whole blood/serum. Plaintiff is entitled to receive the results of the inspection and testing performed by or at the request of Defendant, including the exchange of all data generated as a result of the inspection and testing, photographs, and other information generated as a result of the inspection.

(i) If Plaintiff has taken possession of an Explanted DePuy ASR™ Device and has chosen not to conduct an inspection or testing, Defendant shall have the right to request that the Explanted DePuy ASR™ Device be sent to a contract laboratory of Defendant's choice for inspection and testing. Plaintiff is entitled to receive the results of the inspection and testing,

including the exchange of all data generated as a result of the inspection and testing, photographs, and other information generated as a result of the inspection. Upon completion of Defendant's inspection and testing, Plaintiff shall be entitled to have the Explanted DePuy ASR™ Device sent to a contract laboratory of Plaintiff's choice for further inspection and testing, with Defendant entitled to receive the results of the inspection and testing, including the exchange of all data generated as a result of the inspection and testing, photographs, and other information generated as a result of the inspection.

**E. Dissemination of this Order**

Defendant shall disseminate this Order to surgeons and hospital representatives who were recipients of its letter dated September 30, 2010, regarding "Retention of Explanted Components," and in addition to distributors of Defendant's ASR™ Device with a request that the distributors disseminate to its representatives, and by doing so, shall be deemed to have satisfied the Court's expectation that this Order be communicated to non-party medical practitioners and hospitals.

The Parties agree that neither will promote or encourage third parties, including but not limited to physicians and hospital personnel, to act in a way that is inconsistent with this Order or the Preservation Protocols.

**F. Court Oversight of the Process**

The process of obtaining from surgeons and hospitals Explanted DePuy ASR™ Devices, and then sending for inspection, and testing hundreds if not thousands of Explanted DePuy ASR™ Devices at contract laboratories, is likely to encounter complications which the Parties and this Court cannot anticipate at this time. The Court shall retain an active involvement in this process and the Parties shall keep the Court advised of complications encountered. In the event

that a dispute arises between a hospital and a Patient or Patient's counsel regarding the retrieved components, the Patient or Patient's counsel has a right to seek relief in this Court and this Court will intervene to resolve this dispute. To facilitate the Court's involvement in resolving any complications arising from this Order, the Court designates Plaintiff's Lead Counsel Daniel Lapinski (732.855.6066, dlapinski@wilentz.com) and Defense Counsel Bob Tucker (216.696.4093, robert.tucker@tuckerellis.com) as the contact persons who will field any questions and who will bring to the Court those issues requiring Court involvement.

**IT IS SO ORDERED.**

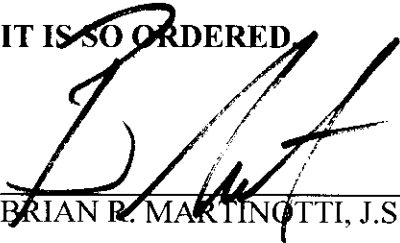

BRIAN R. MARTINOTTI, J.S.C.

FP01/ 6507118.2



# EXHIBIT A

**Procedure for the Decontamination and Preservation of Retrieved DePuy  
ASR or ASR-XL Components and Preservation of Tissue Samples by the  
Hospital or Healthcare Center and Prior to the Shipment to the Storage  
Facility or Contract Laboratory Retained by Either DePuy or the Patient**

*Decontamination/Preservation Procedure*

**Procedure for the Decontamination and Preservation of Retrieved DePuy ASR or ASR-XL Components and Preservation of Tissue Samples by the Hospital or Healthcare Center and Prior to the Shipment to the Storage Facility or Contract Laboratory Retained by Either DePuy or the Patient.**

1. **PURPOSE:**  
The following is an agreed upon protocol for giving instruction to outside parties for the decontamination of retrieved DePuy ASR or ASR-XL components and the preservation of possible tissue sample(s).
2. **SCOPE:**
  - 2.1 THIS PROCEDURE ONLY APPLIES TO ALL DEVICES AND POSSIBLE TISSUE SAMPLE(S) THAT ARE RETRIEVED DURING AND LEADING UP TO THE REVISION SURGERY FOR DEPUY ASR OR ASR-XL COMPONENTS.
  - 2.2 While not being requested by DePuy, DePuy does not object to a patient or the patient's counsel of record making other arrangements for the retention, preservation and shipping by a surgeon and/or the hospital of synovial fluid and whole blood serum for an individual patient.
  - 2.3 Decontamination, preservation and shipment of DePuy devices that do not involve the revision of DePuy ASR or ASR-XL components are to be handled in the customary manner.
3. **PRECAUTIONS:**
  - 3.1 Only personnel trained in handling and shipping infectious substances shall perform this procedure.
  - 3.2 Standard precautions for biological materials must be used when handling the retrieved components and possible tissue samples.
4. **DECONTAMINATION OF EXPLANTS AND PRESERVATION OF TISSUE SAMPLES:**
  - 4.1 Retrieved components shall be decontaminated in accordance with hospital procedures unless a Patient or Patient's counsel of record requests that it be done in a different fashion. DePuy does not object to a patient or a patient's counsel of record making other arrangements with the patient's surgeon and/or the hospital for the fixation or decontamination of retrieved components in a manner other than in accordance with hospital procedures so long as the retrieved components are appropriately decontaminated and preserved.
    - 4.1.1 In the event that a dispute arises between a hospital and Patient or Patient's counsel regarding the manner in which the retrieved components should be decontaminated, preserved and/or shipped, until resolved, the retrieved components shall remain completely immersed in 10% Neutral Buffered Formalin without any alteration or decontamination. If the Patient or Patient's counsel objects to

*Decontamination/Preservation Procedure*

autoclaving, autoclaving should not take place without an order from the Court permitting same.

- 4.2 Tissue samples are to be fixed according to hospital pathology procedures, remain soaked in the fixative and retained in a leak proof container marked as "biohazard" and "hazardous" in accordance with hospital procedures for the fixative unless a patient or a patient's counsel of record requests that it be done in a different fashion. DePuy does not object to a patient or a patient's counsel of record making other arrangements with the patient's surgeon and/or the hospital for the fixation of tissue samples in a manner other than in accordance with hospital procedures so long as the tissue samples are appropriately preserved.
- 4.3 The total sample volume should not be larger than a golf ball in size and should only be taken from tissue removed from areas adjacent to the revised implant that may contain debris from the subject device.
- 4.4 DePuy does not object to a patient or a patient's counsel of record requesting the retention and preservation of synovial fluid and/or whole blood to be packaged, preserved, and shipped in accordance with procedures to be agreed upon by the patient, her counsel of record, and the surgeon and/or hospital.

5. PACKAGING AND TRACKING:

- 5.1 After the decontamination and preservation of retrieved components and after the preservation of tissue, hospitals and health care centers are, to the extent possible, to follow the packaging, tracking and shipment instructions provided by either:
  - 5.1.1 DePuy's procedure for shipment of retrieved DePuy ASR or ASR-XL components from the hospital or Healthcare center to the DePuy contract laboratory **OR**
  - 5.1.2 Per the patient or patient's counsel seeking transfer of these materials pursuant to a duly executed authorization.

6. STORAGE:

- 6.1 The retrieved components and possible tissue samples should be stored in a secured location until a shipping kit and instructions arrive from DePuy, the patient or a representative of the patient.

7. REFERENCES:

- 7.1 Title 21 CFR, Part 803, *Medical Device Reporting*
- 7.2 Title 29 CFR, Part 1910, *Occupational Safety and Health Standards*
- 7.3 ANSI/AAMI ST79, *Comprehensive guide to steam sterilization and sterility assurance in health care facilities*

**Procedure for the Initial Receipt, Photography, and Decontamination of  
DePuy ASR or ASR-XL Components and the Initial Receipt and Photography  
of Tissue Samples, if any, at the Contract Laboratory or Storage Facility**

*Initial Receipt Procedure*

**Procedure for the Initial Receipt, Photography, and Decontamination of DePuy ASR or ASR-XL Components and the Initial Receipt and Photography of Tissue Samples, if any, at the Contract Laboratory or Storage Facility**

1. **PURPOSE:**  
The following protocol describes the processes for the initial receipt of the package, taking photographs of the contents, and decontamination of the retrieved components at the storage facility or contract laboratory retained by the Patient and/or DePuy.
2. **PRECAUTIONS:**
  - 2.1 Tracking and integrity of the retrieved components and other package contents is critical.
  - 2.2 Only one package should be handled at a time for each stage of the process to prevent sample mix-up.
  - 2.3 Personnel performing these procedures shall be trained in handling and disposal of infectious substances, chemical handling, and photography.
  - 2.4 Standard precautions for biological materials must be used when handling the retrieved components, possible tissue samples, and inner-most packaging.
  - 2.5 Although the retrieved components may be labeled as having been previously decontaminated, the components must be decontaminated according to this procedure prior to detailed analysis for personnel safety.
3. **RECEIPT OF PACKAGE BY DEPUY CONTRACT LABORATORY:**
  - 3.1 Do not open the package until instructed to do so within this procedure.
  - 3.2 Inspect the package for shipping damage.
  - 3.3 Identify the DePuy Retrieval number and the tracking number on the package's shipping label (air waybill). These two numbers shall be used for tracking of all retrieved components and possible tissue samples
  - 3.4 Create a label containing both the DePuy Retrieval number and the package's tracking number, which shall be included in the initial macro photographs.
4. **RECEIPT OF PACKAGE BY PATIENT'S CONTRACT LABORATORY OR STORAGE FACILITY:**
  - 4.1 Do not open the package until instructed to do so within this procedure.
  - 4.2 Inspect the package for shipping damage.
  - 4.3 Identify the assigned unique patient identification number and the tracking number on the package's shipping label (air waybill). These two numbers shall be used for tracking of all retrieved components and possible tissue samples
  - 4.4 Create a label containing both the assigned unique patient identification number and the package's tracking number, which shall be included in the initial macro photographs

*Initial Receipt Procedure*

5. **PHOTOGRAPHY OF THE AS-RECEIVED PACKAGE AND CONTENTS:**
  - 5.1 Standard precautions for biological materials must be used per local lab procedures.
  - 5.2 Photography shall be performed with a digital camera, SLR preferred, 8.0 Megapixel minimum, greater than or equal to 12 Megapixel preferred.
  - 5.3 Macro photographs shall include the label with the DePuy Retrieval number or some other unique patient identification number along with the package's tracking number.
  - 5.4 Photography of the outer packaging shall include:
    - 5.4.1 An overall image of the package;
    - 5.4.2 A readable image of the package's air waybill;
    - 5.4.3 And, any significant damage to the outer package.
  - 5.5 Carefully open the outer package, so as to not damage the contents.
  - 5.6 At each step of unpacking the contents of the package, take photographs of the packing materials and labels.
  - 5.7 Retain the outer-most package for future storage, and the cardboard tray with plastic film for future shipping.
  - 5.8 Take a readable photograph of the paperwork found inside the package and any other paperwork in the air waybill pouch that was not visible when photographing the outside of the package.
    - 5.8.1 Confirm that the DePuy Retrieval number or some other unique patient identification number listed in the paperwork matches that on the package's air waybill.
    - 5.8.2 If the DePuy Retrieval number or some other unique patient identification number listed in the paperwork does not match that on the package's air waybill, create a label containing both numbers plus the package tracking number which shall be included in the initial macro photographs from this point forward. DePuy contract laboratories should report any such discrepancy in the regular Transmission of Information to DePuy. A patient retained contract laboratory or storage facility should report such a discrepancy to the patient.
    - 5.8.3 If the DePuy Retrieval number or some other unique patient identification number was not shown on the shipping label (air waybill), and is now found on the paperwork or component labels, create a label containing the DePuy Retrieval number or some other unique patient identification number along with the package's tracking number which shall be included in the initial macro photographs from this point forward.
  - 5.9 Inspect the package containing the tissue sample(s), if provided.
    - 5.9.1 Take photographs of the packing materials and labels at each step of opening the contents of the package.

*Initial Receipt Procedure*

- 5.9.2 Transfer the tissue sample(s) to a new, labeled leak-proof container, and add 10% neutral buffered formalin solution until the sample is submerged.
  - 5.10 As-received photography of the retrieved components shall include:
    - 5.10.1 An image of each component with the inner-most packaging in which it was contained;
    - 5.10.2 At least two overall images (opposing views) of all retrieved components together, on a plain background, with a scale to indicate size. The Resurfacing Head and Cup must be positioned with the DP or DEPUY identification marking at the 12 o'clock position in both images. The ASR-XL Head must be positioned with the identification marking aligned left to right (when the marking is in view) or right to left (when the marking is face down);
    - 5.10.3 At least two overall images (opposing views) of each individual retrieved component, on a plain background, with a scale to indicate size. The Resurfacing Head and Cup must be positioned with the DP or DEPUY identification marking at the 12 o'clock position in both images. The ASR-XL Head must be positioned with the identification marking aligned left to right (when the marking is in view) or right to left (when the marking is face down);
    - 5.10.4 Readable images of each component's identification (laser) markings;
    - 5.10.5 And, images of each component at various magnifications to document noteworthy features.
  - 5.11 Components with attached tissue, including femoral surface replacement components with contained femoral head bone should be transferred to a new, labeled leak proof container, and add 10% neutral buffered formalin solution until each component is submerged.
  - 5.12 A label containing either the DePuy Retrieval number or some other unique patient identification number should be affixed to each new leak-proof container.
6. DECONTAMINATION OF RETRIEVED COMPONENTS:
- 6.1 Decontamination of the retrieved components shall be performed before further analysis is conducted.
  - 6.2 A 10% neutral buffered formalin solution shall be prepared for decontaminating the retrieved components. Ensure that the formalin has not surpassed its expiration date. Refer to the manufacturer's material safety datasheet (MSDS) and instructions for safe handling, personal protective equipment, storage, and disposal.
  - 6.3 Place the retrieved components individually into separate containers labeled with the DePuy retrieval number or some other unique patient identification number as well as the package's tracking number. Add enough formalin solution to cover the components. Record information requested on the attached certification.



*Initial Receipt Procedure*

- 6.4 Allow the retrieved components to soak in the formalin solution for a minimum of 12 hours in a laboratory vented fume hood for the purpose of decontamination.
- 6.5 Components with no attached tissue proceed with steps below else go to step 6.6.
  - 6.5.1 Remove the retrieved components from soaking, rinse with running water for approximately 1 minute. Allow products to dry.
  - 6.5.2 Transfer the dry, decontaminated, retrieved components into individual plastic bags to prevent the components from contacting each other. The individual bags shall be labeled with the DePuy retrieval number or some other unique patient identification number as well as the package's tracking number.
  - 6.5.3 Place the individual bags into a larger plastic bag also labeled with the DePuy retrieval number or some other unique patient identification number as well as the package's tracking number.
  - 6.5.4 Complete and sign the Certification of Decontamination and Component Identification.
  - 6.5.5 Place a copy of the Certification of Decontamination and Component Identification in the larger plastic bag labeled with the DePuy retrieval number or some other unique patient identification number as well as the package's tracking number, alongside the small bags containing the decontaminated retrieved components.
  - 6.5.6 Go to step 6.7
- 6.6 Components with attached tissue, including femoral surface replacement components with contained femoral head bone, proceed with the steps below
  - 6.6.1 After the initial decontamination period of 12 hours, store the components in individual containers submerged in fresh formalin solution until further testing is to be performed.
  - 6.6.2 Each individual container shall be labeled with either, the DePuy retrieval number or some other unique patient identification number as well as the package's tracking number.
  - 6.6.3 Complete and sign the Certification of Decontamination and Component Identification.
  - 6.6.4 Place a copy of the Certification of Decontamination and Component Identification with the collection of individual containers for each patient.
  - 6.6.5 Components should not be handled until the tissue is properly fixed. Tissue fixation can take a few days for small pieces of tissue covering acetabular components, up to a few weeks for femoral surface replacements components with contained femoral head bone.
  - 6.6.6 Should an inspection require the components to be dry, those components should be rinsed with water and the surfaces dried at room temperature under a vented fume hood. Care should be taken

***Initial Receipt Procedure***

to minimize the time that the implants are out of formalin to avoid tissue damage.

6.6.7 At the completion of any testing, components should be returned to their individual containers submerged in formalin solution.

6.7 For cleanup after photography, the inner-most and biohazardous-labeled packaging shall be disposed of as biohazardous waste.

7. **VERIFY THAT THE RETRIEVED COMPONENTS ARE ASR OR ASR-XL:**

7.1 Use the attached "Identification of DePuy ASR or ASR-XL Components" document in order to determine if any of the retrieved components are ASR or ASR-XL.

7.2 If none of the retrieved components are believed to be ASR or ASR-XL, notify DePuy during the regular Transmission of Information.

8. **REFERENCES:**

8.1 Title 29 CFR, Part 1910, *Occupational Safety and Health Standards*

8.2 Centers for Disease Control, *Guideline for Disinfection and Sterilization in Healthcare Facilities*, 2008

9. **ATTACHMENTS:**

9.1 *Certification of Decontamination and Component Identification*

9.2 *Identification of DePuy ASR or ASR-XL Components*

Initial Receipt Procedure

### Laboratory Certification of Decontamination and Component Identification

10% Neutral Buffered Formalin Used: \_\_\_\_\_  
 Vendor: \_\_\_\_\_ Solution Lot #: \_\_\_\_\_  
 Expiration Date: \_\_\_\_\_ Activation Date: \_\_\_\_\_  
 Soak Start Date: \_\_\_\_\_ Soak Start Time: \_\_\_\_\_ AM/PM  
 Soak End Date: \_\_\_\_\_ Soak End Time: \_\_\_\_\_ AM/PM  
 Total Soak Time: \_\_\_\_\_

**Minimum soak 12 hours for decontamination.**

DePuy Retrieval Number or Patient assigned identification number: \_\_\_\_\_  
 Package's tracking number: \_\_\_\_\_

Was a separate tissue sample included? YES [ ] NO [ ]

Tissue Sample Label Information: \_\_\_\_\_

**Record each component's identification (laser) marking information:**

 or \_\_\_\_\_  
 Head: \_\_\_\_\_

 or \_\_\_\_\_  
 Cup: \_\_\_\_\_

 \_\_\_\_\_  
 Sleeve Adapter: \_\_\_\_\_

 \_\_\_\_\_  
 Hip Stem: \_\_\_\_\_

Other components: \_\_\_\_\_

Other components: \_\_\_\_\_

***These retrieved components have been decontaminated per the procedure specified in this protocol.***

Signature of laboratory representative: \_\_\_\_\_ Date: \_\_\_\_\_

PRINT NAME & TITLE: \_\_\_\_\_

*Initial Receipt Procedure*

**Identification of DePuy ASR or ASR-XL Components**

ASR Resurfacing System

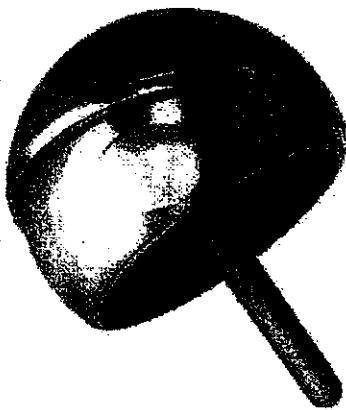

ASR-XL Modular System



**BEFORE PROCEEDING WITH ANY ANALYSIS, CONFIRM THAT AT LEAST ONE OF THE FOUR COMPONENTS SHOWN BELOW IS PRESENT.**

ASR Acetabular Cup  
100 Series

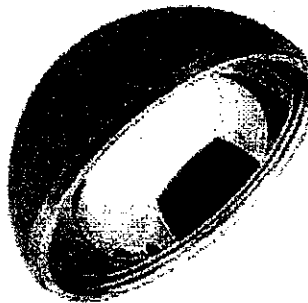

ASR Acetabular Cup  
300 Series

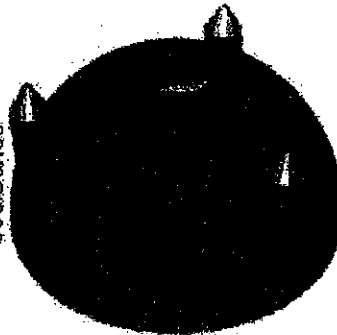

ASR-XL Head with Tapered  
Sleeve Adapter

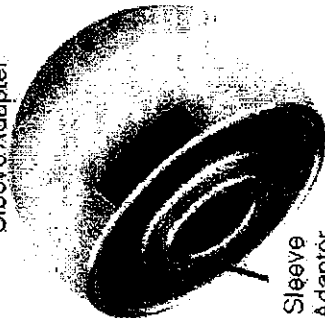

ASR Resurfacing Head

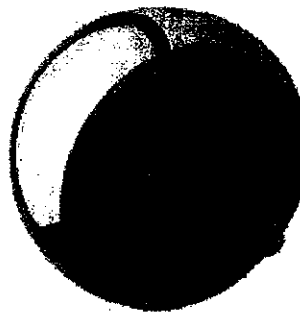

Sleeve  
Adapter

**PROCEDURE FOR LABORATORY INSPECTION OF  
ASR, ASR-XL AND RELATED COMPONENTS**

**PROCEDURE FOR LABORATORY INSPECTION OF  
ASR, ASR-XL AND RELATED COMPONENTS**

**SUMMARY OF REQUESTED INSPECTIONS AND REQUESTED CAPABILITIES**

<b>Requested Capabilities:</b>	
<b>Metal Component Inspection</b>	
Photography of received biohazardous components as received:	
Sealed package as received + each opening step	
Overall view of all components	
Identification markings on all components	
Decontamination in 10% buffered formalin	
Photography of decontaminated components:	
Overall view of each component	
Bearing surfaces	
Bone ingrowth/cemented surfaces	
Bone and/or Implant fracture surfaces if present	
Detailed photos of burnishing, damage to bearings or fixation surfaces, extent of wear scar, corrosion, etc	
Macro and Stereomicroscopic examination of each component	
General shape, damage, retrieval and/or post-retrieval artefacts, wear, burnishing, scratches, corrosion, embedded material/particles, discoloration, staining, polishing or hazing of original features, etc	
Identification and description of bone and/or soft tissue present on ingrowth surfaces	
Observations of porous and/or HA coated surfaces: damage, missing, etc	
Identification and description of bone and/or cement present on cemented surfaces	
Metrology:	
Coordinate Measurement Machine (CMM) surface profiling for measurement to identified engineering drawing dimensions	
Surface Finish measurement ( $R_a$ ) with an appropriate non-contact and/or contact profilometry method per ASME B46.1	

**1.0 PURPOSE**

The purpose of this document is to provide a protocol for inspection of ASR, ASR-XL and related retrieved components at external facilities.

**2.0 SCOPE**

This work instruction to laboratories details the steps required to inspect ASR, ASR-XL and related components at external test facilities. It applies to components previously decontaminated, with stepwise photography of the unpacking procedure. A verification of the complaint number, patient information, product information, and patient authorization/consent must also have been completed prior to performing this inspection.

*Laboratory Retrieval Inspection Procedure*

**3.0 REFERENCES**

- 3.1 ASME B46.1, Surface Texture (Surface Roughness, Waviness, and Lay)
- 3.2 ASTM F561, Standard Practice for Retrieval and Analysis of Medical Devices, and Associated Tissues and Fluids
- 3.3 ASTM F 2033, Standard Specification for Total Hip Joint Prosthesis and Hip Endoprosthesis Bearing Surfaces Made of Metallic, Ceramic, and Polymeric Materials
- 3.3 ISO 7206-2, Implants for Surgery - Partial and Total Hip Joint Prostheses - Part 2: Articulating Surfaces Made of Metallic, Ceramic and Plastics Materials
- 3.4 ISO 12891-1, Retrieval and Analysis of Surgical Implants - Part 1: Retrieval and Handling
- 3.5 ISO 12891-2, Retrieval and Analysis of Surgical Implants - Part 2: Analysis of Retrieved Metallic Surgical Implants

**4.0 MATERIALS**

- 4.1 Retrieved components supplied with a DePuy Retrieval identifier
- 4.2 Digital camera, SLR preferred; 8.0 Megapixel minimum,  $\geq 12$  Megapixel preferred
- 4.3 Optical Stereomicroscope
- 4.4 Coordinate Measurement Machine (CMM) of sufficient accuracy to determine spherical diameters and sphericity per ASTM F2033 or ISO 7206-2.
- 4.5 Non-contact or Contact Profilometer – capable of  $R_a$  measurements on the order of 5-100 nm per ASME B46.1.

**5.0 PROCEDURE**

- 5.1 Except as specifically set forth in this Laboratory Retrieval Inspection Procedure, all handling of implants must be performed non-destructively; this includes all inspection, examination or other actions that may alter the original, as-found nature, state or condition of components.
- 5.2 Tracking and integrity of the retrieved components is critical. Appropriate segregation and handling procedures shall be performed to prevent the possibility of mixing multiple retrieval cases.
- 5.3 Verify overview photography of components from unpacking and prior to decontamination (photos shall include in view: DePuy retrieval identification and tracking number).
  - 5.3.1 Sequential images of unpacking of received components
  - 5.3.2 Overall image of all components received, two orientations
  - 5.3.3 Individual image of each component received, two orientations
  - 5.3.4 Images of each component with readable laser mark identifications
  - 5.3.5 Images of any noteworthy features
- 5.4 Obtain a set of standard detailed photos. Articular surfaces may be wiped with isopropyl alcohol and a cotton ball or swab, or lint-free cloth to remove dried fluid or water spot artefact that may obscure features of the articular surface.

*Laboratory Retrieval Inspection Procedure*

- 5.4.1 Group and individual overall views of the components shall be obtained (entire component in view within the image). Resurfacing Head and Cup must be positioned with the "DP" or "DePuy" lasermark at the 12 o'clock position, refer to Appendix 1 and Appendix 2 for schematics. ASR XL Head shall be oriented with the lasermark information aligned left to right (lasermark in view) or right to left (lasermark face down), refer to Appendix 3 for schematics. Images shall contain DePuy Retrieval identification and scale in each view.
  - 5.4.1.1 Once oriented, using a "sharpie" style marker, marks may be drawn only on non-articulating, smooth surfaces (ie on the rim or edges of either the heads or the cups) of each component in order to delineate the quadrants or sectors as specified in the Appendices 1, 2, 3, 4 and 5. Do not draw lines on any coated or articulating surface.
  - 5.4.1.2 At least two overall images (opposing views) of all retrieved components together, on a plain background.
  - 5.4.1.3 At least two overall images (opposing views) of each individual retrieved component, on a plain background. If a hip stem is included, overall images of the medial and lateral aspects of the stem are also required (in addition to Side A and Side B, as shown in Appendix 5).
- 5.4.2 Detailed photography shall also be performed (only a portion of the component in view within the image). The images shall be saved with file name information indicating location information (Example: Cup\_Articular3R.jpg). When feasible, images shall contain DePuy Retrieval identification and scale in each view. Otherwise, the file name of the image shall also identify the DePuy Retrieval number.
  - 5.4.2.1 Clear images of lasermark identification of each component
  - 5.4.2.2 Quadrant views of each component, following the reference quadrants defined in Appendices 1-5 (minimum 8 views).
  - 5.4.2.3 Additionally, the features of each component shall be photodocumented at appropriate magnifications. Examples of features to be noted if they exist include, but are not limited to, bone fracture surfaces, implant fracture surfaces, burnishing, damage, wear scar, corrosion, foreign material, discoloration, and missing porous coating.
- 5.5 A component specific form shall be completed for each component received to detail the specific observations for that component, see Appendices 1 - 5. Record the DePuy Retrieval Number, Patient Name, Patient Date of Birth (DOB), Revising Institution, and laser marking information on each component form.
- 5.6 **Macro and stereomicroscopic examination**
  - 5.6.1 Perform macroscopic examination with the unaided eye or with the aid of an optical stereomicroscope. Examine all surfaces of each component for evidence of in-service, retrieval and/or post-retrieval damage. Record observations with a score (herein referred to as Area Score) to indicate the amount of area affected by the observed feature on a zero to three scale, with "0" indicating none of surface affected, "1" indicating greater than none but less than 25% of the area affected,



*Laboratory Retrieval Inspection Procedure*

“2” indicating between 25% and 75%, inclusive, of the area affected, and “3” indicating greater than 75% of the area affected.

- 5.6.2 Every effort should be made to photodocument every feature noted. The images shall be saved with file name information indicating location information (Example: ComponentX\_Area3A\_burnishing.jpg). In the instance that a feature cannot be made apparent in an image, the feature shall be fully characterized: described in words, sketched, and noted with size and location information. The amount of area affected by an observed feature shall be scored.
- 5.6.3 Articular surfaces may be wiped with alcohol and a cotton ball or swab, or lint-free cloth to remove dried fluid or water spot artefact that may obscure features of the articular surface.
- 5.6.4 Scratches may be defined into three categories:
  - 5.6.4.1 Light: Can be seen but not felt/detected with a fingernail or a 0.18 mm thickness acetate gage.
  - 5.6.4.2 Moderate: Can be seen and felt/detected with a fingernail or a 0.18 mm thickness acetate gage.
  - 5.6.4.3 Heavy: Distinctly seen, felt/detected and will catch or stop a fingernail or 0.18 mm acetate gage.
- 5.6.5 Disassembly of components may only be performed after the party who has not yet had an opportunity to inspect and test has been notified and been given an opportunity to first perform any/all non-destructive testing on the explants.
  - 5.6.5.1 A party may not proceed with disassembly until notification is provided to, and authorization is received from, the opposing party.

**5.7 Metrology**

- 5.7.1 For ASR Acetabular and ASR femoral components, CMM measurements shall be made (see Appendices 1-3). Spherical diameter and the circularity, also called Sphericity, shall be measured following the methods of ISO 7206-2 (Method A.1 for a femoral head and A.2 for an acetabular cup) or ASTM F2033. Additionally, true position of the sphere center with respect to two defined datums shall be made for acetabular components only. Results shall be recorded on the component specific form (see Appendices 1-3) and a report of the raw CMM data shall be attached to the component specific form.
- 5.7.2 For ASR Acetabular and ASR femoral components, contacting and/or non-contacting surface profilometry measurements shall be made according to ASME B46.1. Measurements shall be taken in the three defined locations shown in the Appendices 1-3. The three locations shall be: one at the pole of the articular surface; and two locations 30° from the pole, 180° from each other. The results may be suitably filtered in order to appropriately separate roughness, waviness and form.
  - 5.7.2.1 Non contacting profilometry surface roughness ( $S_a$ ) shall be measured for acetabular and femoral components in accordance with the default parameters of ASME B46.1 for non-contacting optical equipment. The surface scan shall be taken using a nominal 20 times objective lens and examine an area for each measurement of between 225-340 microns by 225-340 microns. Results shall be recorded on the component specific

*Laboratory Retrieval Inspection Procedure*

form (see Appendices 1-3) and a report of the raw profilometry data shall be attached to the component specific form.

5.7.2.2 Contacting profilometry surface roughness ( $R_a$ ) shall be measured for the acetabular and femoral components in accordance with ASME B46.1. The stylus shall have a diamond tip and a nominal spherical tip radius of 2.0 (two) microns. The scans shall start with a cutoff length of 0.08 mm and a minimum evaluation length of 0.40 mm. For higher surface  $R_a$  results, adjustments to the cutoff and evaluation length shall be made according to ASME B46.1 Table 3.2 and the scan repeated. Results shall be recorded on the component specific form (see Appendices 1-3) and a report of the raw profilometry data shall be attached to the component specific form.

- 5.7 Storage of components and associated documentation shall be per DePuy "Procedure for the Storage of Retrieved Components at the Contract Laboratory"
- 5.8 No further inspection of tissue samples is required. Any tissue samples received shall be retained per DePuy "Procedure for the Storage of Retrieved Components at the Contract Laboratory".

## 6.0 REPORT

- 6.1 Each component specific form shall be signed and dated by the associate. The compiled report of forms, attachments, and acquired images shall be signed and dated upon completion by a reviewer.
- 6.2 The results of the inspection will be provided in a formal report using the completed forms and required attachments and submitted to DePuy. The report will be reviewed and additional inspection may be requested.

Laboratory Retrieval Inspection Procedure Appendix 1: ACETABULAR CUP

DePuy Retrieval Number: \_\_\_\_\_

**TITLE: FORM FOR LABORATORY INSPECTION OF ASR ACETABULAR CUP**

Patient Name: \_\_\_\_\_  
 DOB: \_\_\_\_\_  
 Revising Institution: \_\_\_\_\_

ASR Acetabular Cup  
 100 Series



Lasermark: DP \_\_\_\_\_ C  
 SIZE \_\_\_\_\_

Quadrant reference system  
 for articular surface

Quadrant reference system  
 for ingrowth surface

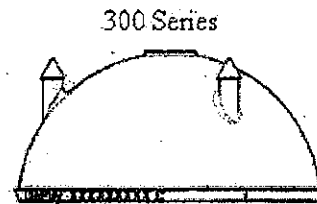
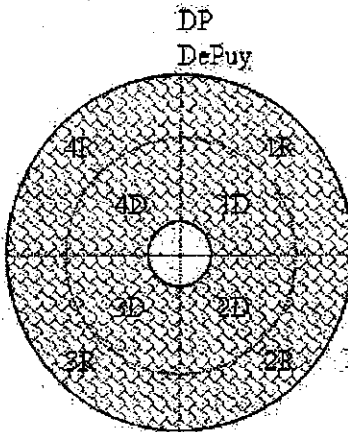
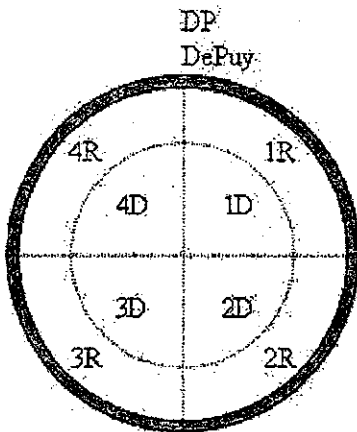

Lasermark: DePuy \_\_\_\_\_ C  
 SIZE \_\_\_\_\_

NOTE: Orient with "DP" or "DePuy" at 12 o'clock position, for consistency of location references.

Articular surfaces	1D	1R	2D	2R	3D	3R	4D	4R
Generally hemi-spherical in shape: YES [ ] NO [ ]								
If NO, denote location of non-uniformity with "X"								
Evidence of a clear wear zone? If YES, denote Location								
Area Score: (0: None, 1: <25%, 2: 25-75%, 3: >75%)								
Scratches: (See section 5, 6.4)								
Light (visually apparent but no perceived depth)								
Moderate (slightly perceived depth)								
Heavy (Depth to scratch is evident)								
Impingement:								
Corrosion:								
Embedded Material/Particles:								
Discoloration/Staining:								
Hazy Appearance								
OTHERS:								

Laboratory Retrieval Inspection Procedure Appendix 1: ACETABULAR CUP

DePuy Retrieval Number: \_\_\_\_\_

**TITLE: FORM FOR LABORATORY INSPECTION OF ASR ACETABULAR CUP**

Non-articular surfaces:	1D	1R	2D	2R	3D	3R	4D	4R
Wear or Burnishing								
Scratches (see section 5.6.4)								
Change of shape								
Impingement								
Mechanical/Retrieval damage								
Corrosion								
Embedded material/particles								
Discoloration/staining								
Polishing of non-polished surface features								
Hazing of surface features								
For porous and/or HA coated surfaces								
damage to coating								
missing coating								
attachment of bone tissue								
attachment of soft tissue								
OTHERS:								

**Metrology Evaluation**

Measure and record the following dimensions in mm with CMM (see drawing for clarification):

- SØ "G" \_\_\_\_\_ mm
- Surface Profile (Sphericity) \_\_\_\_\_ mm
- True Position-Datum A \_\_\_\_\_ mm
- True Position-Datum B \_\_\_\_\_ mm

Position Datum A refers to the position of the sphere center with respect to the central axis defined by the chamfer on the outer rim of cup (i.e. distance of sphere center from the central axis). Position Datum B refers to the position of the sphere center with respect the plane defined by the face of the rim of the cup (i.e. distance of sphere center to face of cup).

Measure and record the surface roughness ( $S_a$  or  $R_a$ ) in nm using a profilometer (see schematic for defined locations):

- $S_a1$  \_\_\_\_\_ nm or  $R_a1$  \_\_\_\_\_ nm
- $S_a2$  \_\_\_\_\_ nm or  $R_a2$  \_\_\_\_\_ nm
- $S_a3$  \_\_\_\_\_ nm or  $R_a3$  \_\_\_\_\_ nm

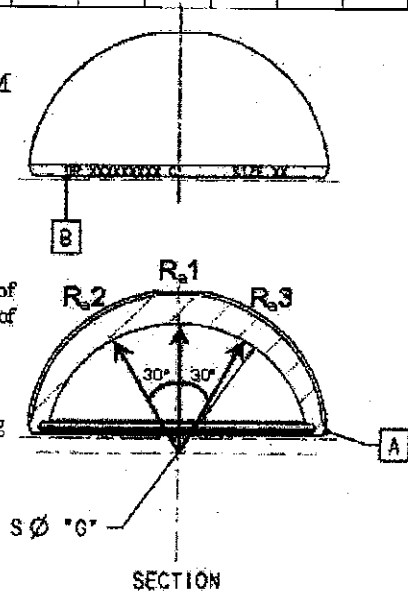

Signature: \_\_\_\_\_ Date: \_\_\_\_\_

PRINT NAME & TITLE: \_\_\_\_\_

Laboratory Retrieval Inspection Procedure Appendix 2: RESURFACING HEAD

DePuy Retrieval Number: \_\_\_\_\_

**TITLE: FORM FOR LABORATORY INSPECTION OF ASR RESURFACING HEAD**

Patient Name: \_\_\_\_\_  
 DOB: \_\_\_\_\_  
 Revising Institution: \_\_\_\_\_

ASR Resurfacing Femoral Head

Quadrant reference system  
 (for articular surface  
 viewed from apex)

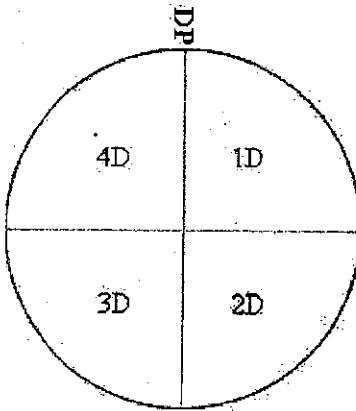

Quadrant reference system  
 (for cemented surface  
 viewed from stem)

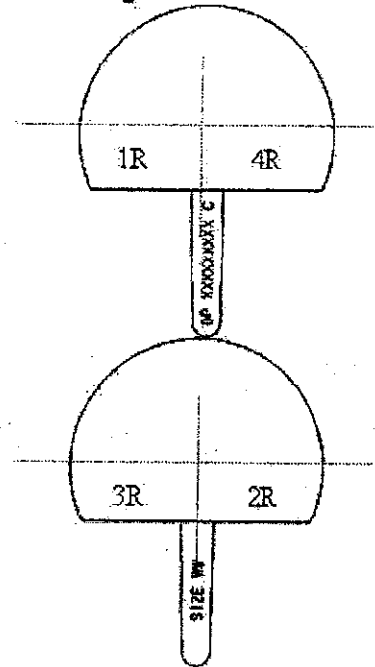
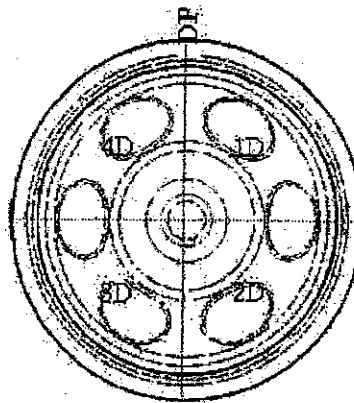

Orient with "DP" on stem of component at 12 o'clock position,  
 for consistency of location references.

Lasermark DP \_\_\_\_\_ C  
 SIZE \_\_\_\_\_

Articular surfaces	1D	1R	2D	2R	3D	3R	4D	4R
Generally hemi-spherical in shape: YES [ ] NO [ ]								
If NO, denote location of non-uniformity with "X"								
Evidence of a clear wear zone? If YES, denote Location								
Area Score: (0: None, 1: <25%, 2: 25-75%, 3: >75%)								
Scratches: (See Section 5.6.4)								
Light (visually apparent but no perceived depth)								
Moderate (slightly perceived depth)								
Heavy (Depth to scratch is evident)								
Impingement								
Corrosion								
Embedded Material/Particles								
Discoloration/Staining								
Hazy Appearance								
OTHERS:								

Laboratory Retrieval Inspection Procedure Appendix 2: RESURFACING HEAD

DePuy Retrieval Number: \_\_\_\_\_

**TITLE: FORM FOR LABORATORY INSPECTION OF ASR RESURFACING HEAD**

Non-articular surfaces	1D	2D	3D	4D	
Area Score: (0: None, 1: <25%, 2: 25-75%, 3: >75%)					
Wear or Burnishing					
Scratches (see Section 5.6.4)					
Change of shape					
Impingement					
Mechanical/Retrieval damage					
Corrosion					
Embedded material/particles					
Discoloration/staining					
Polishing of non-polished surface features					
Hazing of surface features					
OTHERS:					
<b>For cemented surface</b>					
Surface area affected Score: (0: None, 1: <25%, 2: 25-75%, 3: >75%)					
Bone present?					
Out or fractured? Describe appearance in detail:					
Cement present?					
Describe appearance:					

**Metrology Evaluation**

Measure and record the following dimensions in mm with CMM (see drawing for clarification):

SØ "X" \_\_\_\_\_ mm

Circularity (Sphericity) \_\_\_\_\_ mm

Measure and record the surface roughness ( $S_a$  or  $R_a$ ) in nm using a profilometer (see schematic for defined locations):

$S_a1$  \_\_\_\_\_ nm or  $R_a1$  \_\_\_\_\_ nm

$S_a2$  \_\_\_\_\_ nm or  $R_a2$  \_\_\_\_\_ nm

$S_a3$  \_\_\_\_\_ nm or  $R_a3$  \_\_\_\_\_ nm

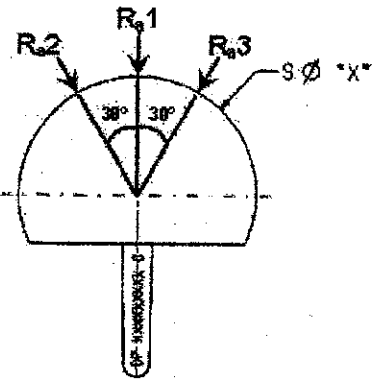

Signature: \_\_\_\_\_ Date: \_\_\_\_\_

PRINT NAME & TITLE: \_\_\_\_\_

Laboratory Retrieval Inspection Procedure Appendix 3: ASR XL HEAD

DePuy Retrieval Number: \_\_\_\_\_

**TITLE: FORM FOR LABORATORY INSPECTION OF ASR XL HEAD**

Patient Name: \_\_\_\_\_  
 DOB: \_\_\_\_\_  
 Revising Institution: \_\_\_\_\_

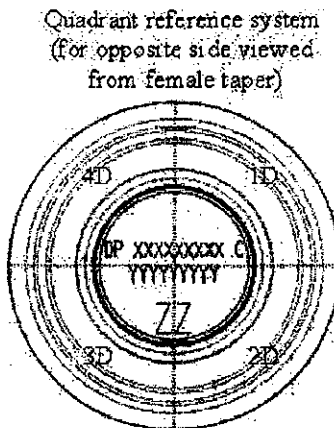
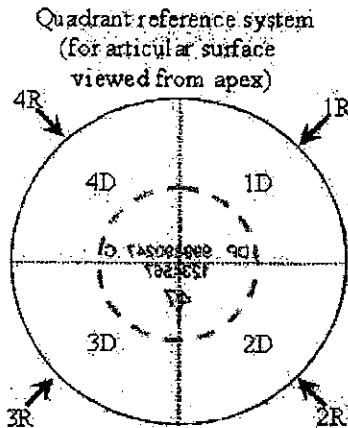
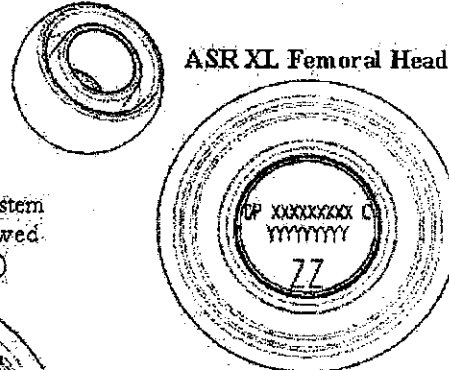

Lasermark: DP \_\_\_\_\_ C  
 \_\_\_\_\_

NOTE: ASR Tapered Sleeve Adapter may be retained within femoral implant.

**DO NOT DISASSEMBLE.**  
 ASR Tapered Sleeve Retained in ASR XL Femoral Head:  
 YES  NO

Views 1-4 "R" are the areas below the equator of the articular surface (toward the rim) with the same numbering convention as 1-4 "D".

Use coordinate system related to inside female taper (of head OR retained taper adapter) as well as recessed area between articular surface and taper.

Orient with "DP" lasermark lines oriented left to right (lasermark in view) or right to left (lasermark face down), as applicable (see schematics), for consistency of location references.

Articular surfaces	1D	1R	2D	2R	3D	3R	4D	4R
Generally hemi-spherical in shape: YES [ ] NO [ ]								
If NO, denote location of non-uniformity with "X"								
Evidence of a clear wear zone? If YES, denote Location								
Area Score: (0: None, 1: <25%, 2: 25-75%, 3: >75%)								
Scratches: (See Section 5.6.4)								
Light (visually apparent but no perceived depth)								
Moderate (slightly perceived depth)								
Heavy (Depth to scratch is evident)								
Corrosion								
Embedded Material/Particles								
Discoloration/Staining								
Hazy Appearance								

Laboratory Retrieval Inspection Procedure Appendix 3: ASR XL HEAD

DePuy Retrieval Number: \_\_\_\_\_

**TITLE: FORM FOR LABORATORY INSPECTION OF ASR XL HEAD**

Articular surfaces, continued	1D	1R	2D	2R	3D	3R	4D	4R
OTHERS:								
<b>Non-articular surfaces</b>	1D	2D	3D	4D				
Area Score: (0: None, 1: <25%, 2: 25-75%, 3: >75%)								
Wear or Burnishing								
Scratches (See Section 5.6.4)								
Change of shape								
Mechanical/Retrieval damage								
Corrosion								
Embedded material/particles								
Discoloration/staining								
Polishing of non-polished surface features								
Hazing of surface features								
OTHERS:								

Metrology Evaluation:

Measure and record the following dimensions in mm with CMM (see drawing for clarification):

SØ "C" \_\_\_\_\_ mm  
 Circularity (Sphericity) \_\_\_\_\_ mm

Measure and record the surface roughness (S<sub>a</sub> or R<sub>a</sub>) in nm using a profilometer (see schematic for defined locations):

S<sub>a1</sub> \_\_\_\_\_ nm or R<sub>a1</sub> \_\_\_\_\_ nm  
 S<sub>a2</sub> \_\_\_\_\_ nm or R<sub>a2</sub> \_\_\_\_\_ nm  
 S<sub>a3</sub> \_\_\_\_\_ nm or R<sub>a3</sub> \_\_\_\_\_ nm

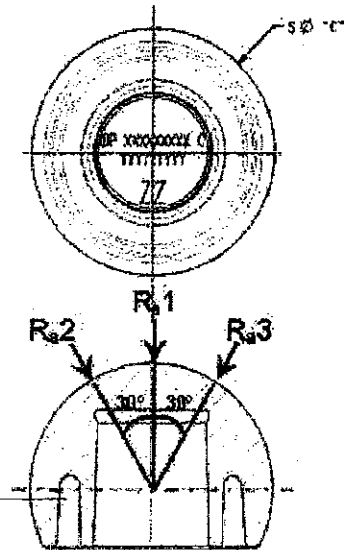

Signature: \_\_\_\_\_ Date: \_\_\_\_\_

PRINT NAME & TITLE: \_\_\_\_\_



Laboratory Retrieval Inspection Procedure Appendix 4: ASR TAPER ADAPTOR

DePuy Retrieval Number: \_\_\_\_\_

**TITLE: FORM FOR LABORATORY INSPECTION OF ASR TAPER ADAPTOR**

Patient Name: \_\_\_\_\_  
 DOB: \_\_\_\_\_  
 Revising Institution: \_\_\_\_\_

ASR Tapered Sleeve Adaptor

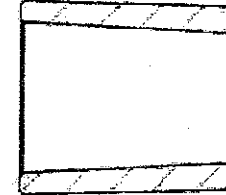

Lasermark: DP \_\_\_\_\_ C \_\_\_\_\_  
 \_\_\_\_\_ MM

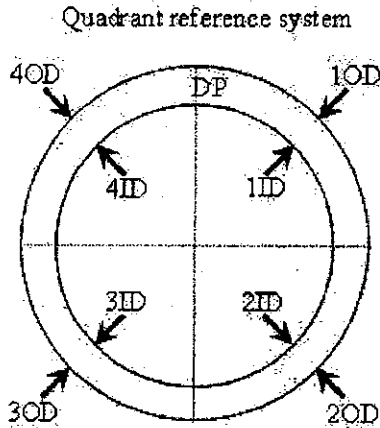

Orient with "DP" at 12 o'clock position, for consistency of location references.

Non-articular surfaces	1OD	1ID	2OD	2ID	3OD	3ID	4OD	4ID
Area Score: (0: None, 1: <25%, 2: 25-75%, 3: >75%)								
Wear or Burnishing								
Scratches (See Section 5.6.4)								
Change of shape								
Mechanical/Retrieval damage								
Corrosion								
Embedded material/particles								
Discoloration/staining								
Polishing of non-polished surface features								
Hazing of surface features								
OTHERS:								

Signature: \_\_\_\_\_ Date: \_\_\_\_\_

PRINT NAME & TITLE: \_\_\_\_\_

DePuy Retrieval Number: \_\_\_\_\_

**TITLE: FORM FOR LABORATORY INSPECTION OF HIP STEM**

Patient Name: \_\_\_\_\_  
 DOB: \_\_\_\_\_  
 Revising Institution: \_\_\_\_\_



Lasermark: \_\_\_\_\_  
 \_\_\_\_\_  
 \_\_\_\_\_

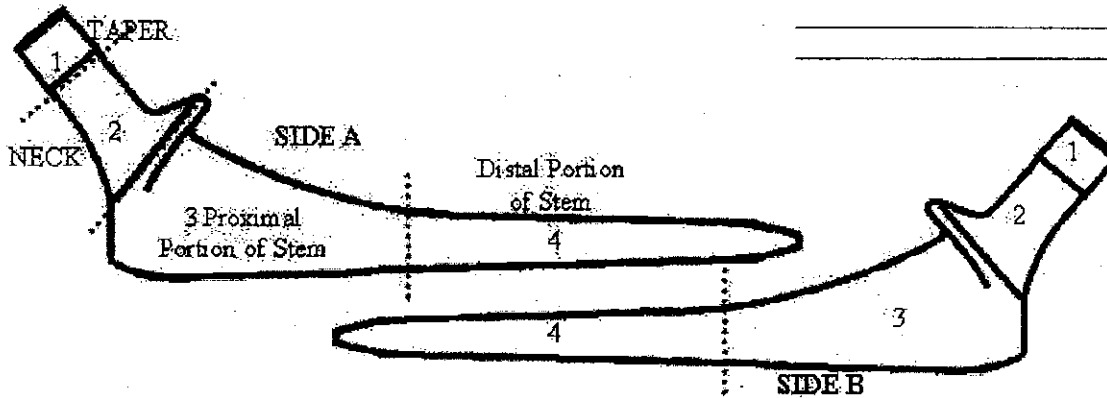

Area Score: (0: None, 1: <25%, 2: 25-75%, 3: >75%)	1A	1B	2A	2B	3A	3B	4A	4B
Wear or Burnishing								
Scratches (See Section 5.5.4)								
Change of shape								
Impingement								
Mechanical/Retrieval damage								
Corrosion								
Embedded material/particles								
Discoloration/staining								
Polishing of non-polished surface features								
Hazing of surface features								
<b>For porous and/or HA coated surfaces</b>								
damage to coating								
missing coating								
attachment of bone tissue								
attachment of soft tissue								
OTHERS:								

Signature: \_\_\_\_\_ Date: \_\_\_\_\_

PRINT NAME & TITLE: \_\_\_\_\_

**Procedure for the Storage of Retrieved Components and/or Tissue Samples  
at the Contract Laboratory and/or Storage Facility**

*Storage Procedure*

**Procedure for the Storage of Retrieved Components and/or Tissue Samples  
at the Contract Laboratory and/or Storage Facility**

1. **PURPOSE:**  
To describe the storage of retrieved components and/or tissue samples and other package contents received.
  
2. **PRECAUTIONS:**
  - 2.1 Tracking and integrity of the retrieved components and other package contents is critical.
  - 2.2 Only personnel trained in handling biological materials and chemical handling shall perform this procedure.
  - 2.3 The retrieved components shall have already been decontaminated by the DePuy procedure.
  - 2.4 The inner-most and biohazardous-labeled packaging around the retrieved components shall have been properly disposed of upon decontamination of the retrieved components. This particular packaging shall not be retained and shall not be stored with the decontaminated retrieved components.
  - 2.5 Standard precautions for biological materials must be used when handling the possible tissue sample(s).
  
3. **ITEMS TO STORE:**
  - 3.1 The following items for each patient may be stored in the outer-most shipping package labeled with the corresponding DePuy Retrieval number or some other unique patient identification number along with the package's tracking number:
    - 3.1.1 The decontaminated retrieved components in their individual containers and inside a larger container, all labeled with either the DePuy Retrieval number or some other unique patient identification number along with the package's tracking number;
    - 3.1.2 The copy of the Certification of Decontamination and Component Identification with the retrieved components;
    - 3.1.3 The package shipment paperwork;
    - 3.1.4 Retrieved component(s) with fixed tissue, if any, shall be retained in biohazardous packaging;
    - 3.1.5 The tissue sample(s), if any, in biohazardous packaging;
    - 3.1.6 A copy of the inspection report and all supporting documentation including images;
    - 3.1.7 And, other possible package contents received such as medical records, x-rays, etc....
  
4. **STORAGE:**
  - 4.1 Storage of retrieved components shall occur in a secured location.